

SMD Surface Mount 0805 Series





Applications

- Over current and over temperature protection of automotive electronics
- PC motherboards, Hard disk driver, and PC peripherals
- POS Equipment
- LCD / LED HDTV
- USB port protection
- HDMI source protection

Features

- Surface Mount Devices
- Standard 0805mils footprint
- Surface Mount packaging for automated assembly
- Compatible with Pb and Pb-free solder reflow profiles

Agency Approvals

AGENCY	AGENCY FILE NUMBER
	E352136
	R50306074

Regulation/Standard



Electrical Characteristic

P/N	I _{hold} (A)	I _{trip} (A)	V _{max.} (V)	I _{max} (A)	Time To Trip		Pd _{typ} (W)	Resistance		Agency Approvals	
					Current (A)	Time (Sec.)		R _{min} (Ω)	R _{1max} (Ω)	UL/CSA	TUV
TLC-PSMD005	0.05	0.15	30	100	0.25	1.50	0.50	3.60	50.0	×	×
TLC-PSMD005/60	0.05	0.15	60	40	0.25	1.50	0.50	3.60	50.0	×	×
TLC-PSMD010	0.10	0.30	15	100	0.50	1.50	0.50	1.00	7.50	√	√
TLC-PSMD010/24	0.10	0.30	24	100	0.50	1.50	0.50	1.00	7.50	√	√
TLC-PSMD020	0.20	0.50	9	100	8.0	0.02	0.50	0.65	3.50	√	√
TLC-PSMD020/12	0.20	0.50	12	100	8.0	0.02	0.50	0.65	3.50	×	×
TLC-PSMD030	0.30	0.75	6	100	8.0	0.10	0.50	0.25	1.20	×	×
TLC-PSMD035	0.35	0.75	6	100	8.0	0.10	0.50	0.25	1.20	√	√
TLC-PSMD035/9	0.35	0.75	9	100	8.0	0.10	0.50	0.25	1.20	×	×
TLC-PSMD035/12	0.35	0.75	12	100	8.0	0.10	0.50	0.25	1.20	×	×
TLC-PSMD050	0.50	1.00	6	100	8.0	0.10	0.50	0.15	0.90	√	√
TLC-PSMD050/9	0.50	1.00	9	100	8.0	0.10	0.50	0.15	0.90	×	×
TLC-PSMD075	0.75	1.50	6	100	8.0	0.20	0.60	0.09	0.35	√	√
TLC-PSMD075/8	0.75	1.50	8	100	8.0	0.20	0.60	0.09	0.35	×	×
TLC-PSMD100	1.00	2.00	6	100	8.0	0.30	0.60	0.06	0.25	√	√
TLC-PSMD100/13.2	1.00	2.00	13.2	50	8.0	0.30	0.60	0.070	0.325	×	×
TLC-PSMD110	1.10	2.20	6	100	8.0	0.30	0.60	0.06	0.21	√	√
TLC-PSMD110/13.2	1.10	2.20	13.2	50	8.0	0.30	0.60	0.070	0.325	×	×
TLC-PSMD150	1.50	3.00	6	100	8.0	0.50	0.60	0.04	0.16	×	×

I_{hold} : Holding Current: maximum current at which the device will not trip in 25°C still air.

I_{trip} : Tripping Current minimum current at which the device will trip in 25°C still air.

V_{max} : Maximum voltage device can withstand without damage at rated current.

I_{max} : Maximum fault current device can withstand without damage at rated voltage. Time To

Trip: Maximum time to trip(s) at assigned current.

Pd_{typ} : Rated working power.

R_{min} : Minimum resistance of device prior to trip at 25°C.

$R1_{max}$: Maximum resistance of device is measured one hours post reflow at 25°C.

Noted: All electrical function test is conducted after PCB mounted.

Thermal Derating Chart – I_{hold}/I_{trip} (Amps)

P/N	Test item	Ambient Operating Temperature								
		-40°C	-20°C	0°C	25°C	40°C	50°C	60°C	70°C	85°C
TLC-PSMD005	I-hold	0.080	0.070	0.060	0.050	0.045	0.040	0.035	0.030	0.025
	I-trip	0.240	0.210	0.180	0.150	0.135	0.120	0.105	0.090	0.075
TLC-PSMD005/60	I-hold	0.080	0.070	0.060	0.050	0.045	0.040	0.035	0.030	0.025
	I-trip	0.240	0.210	0.180	0.150	0.135	0.120	0.105	0.090	0.075
TLC-PSMD010	I-hold	0.15	0.13	0.12	0.10	0.09	0.08	0.07	0.06	0.05
	I-trip	0.45	0.39	0.36	0.30	0.27	0.24	0.21	0.18	0.15
TLC-PSMD010/24	I-hold	0.15	0.13	0.12	0.10	0.09	0.08	0.07	0.06	0.05
	I-trip	0.45	0.39	0.36	0.30	0.27	0.24	0.21	0.18	0.15
TLC-PSMD020	I-hold	0.28	0.25	0.23	0.20	0.17	0.14	0.12	0.10	0.07
	I-trip	0.70	0.63	0.58	0.50	0.43	0.35	0.30	0.25	0.18
TLC-PSMD020/12	I-hold	0.28	0.25	0.23	0.20	0.17	0.14	0.12	0.10	0.07
	I-trip	0.70	0.63	0.58	0.50	0.43	0.35	0.30	0.25	0.18
TLC-PSMD030	I-hold	0.47	0.44	0.39	0.30	0.27	0.24	0.20	0.14	0.10
	I-trip	1.01	0.94	0.84	0.75	0.64	0.58	0.51	0.43	0.30
TLC-PSMD035	I-hold	0.47	0.44	0.39	0.35	0.30	0.27	0.24	0.20	0.14
	I-trip	1.01	0.94	0.84	0.75	0.64	0.58	0.51	0.43	0.30
TLC-PSMD035/9	I-hold	0.47	0.44	0.39	0.35	0.30	0.27	0.24	0.20	0.14
	I-trip	1.01	0.94	0.84	0.75	0.64	0.58	0.51	0.43	0.30
TLC-PSMD035/12	I-hold	0.47	0.44	0.39	0.35	0.30	0.27	0.24	0.20	0.14
	I-trip	1.01	0.94	0.84	0.75	0.64	0.58	0.51	0.43	0.30
TLC-PSMD050	I-hold	0.68	0.62	0.55	0.50	0.40	0.37	0.33	0.29	0.23
	I-trip	1.36	1.24	1.10	1.00	0.80	0.74	0.66	0.58	0.46
TLC-PSMD050/9	I-hold	0.68	0.62	0.55	0.50	0.40	0.37	0.33	0.29	0.23
	I-trip	1.36	1.24	1.10	1.00	0.80	0.74	0.66	0.58	0.46
TLC-PSMD075	I-hold	1.00	0.90	0.79	0.75	0.63	0.57	0.53	0.42	0.35
	I-trip	2.00	1.80	1.58	1.50	1.26	1.14	1.06	0.84	0.70
TLC-PSMD075/8	I-hold	1.00	0.90	0.79	0.75	0.63	0.57	0.53	0.42	0.35
	I-trip	2.00	1.80	1.58	1.50	1.26	1.14	1.06	0.84	0.70
TLC-PSMD100	I-hold	1.45	1.35	1.20	1.00	0.92	0.84	0.75	0.65	0.52
	I-trip	2.90	2.70	2.40	2.00	1.84	1.68	1.50	1.30	1.04
TLC-PSMD100/13.2	I-hold	1.25	1.20	1.10	1.00	0.88	0.70	0.60	0.55	0.50
	I-trip	2.50	2.40	2.20	2.00	1.76	1.40	1.20	1.10	1.00

TLC-PSMD110	I-hold	1.45	1.35	1.20	1.10	0.92	0.84	0.75	0.65	0.52
	I-trip	2.90	2.70	2.40	2.20	1.84	1.68	1.50	1.30	1.04
TLC-PSMD110/13.2	I-hold	1.30	1.25	1.15	1.10	0.90	0.72	0.63	0.58	0.50
	I-trip	2.60	2.50	2.30	2.20	1.80	1.44	1.26	1.16	1.00
TLC-PSMD150	I-hold	1.98	1.84	1.64	1.50	1.25	1.15	1.02	0.89	0.71
	I-trip	3.96	3.68	3.28	3.00	2.50	2.30	2.02	1.78	1.42

Notes: The temperature derating data is for reference only. Please contact TLC technical support for detail temperature derating information.

Typical time to trip at 25°C

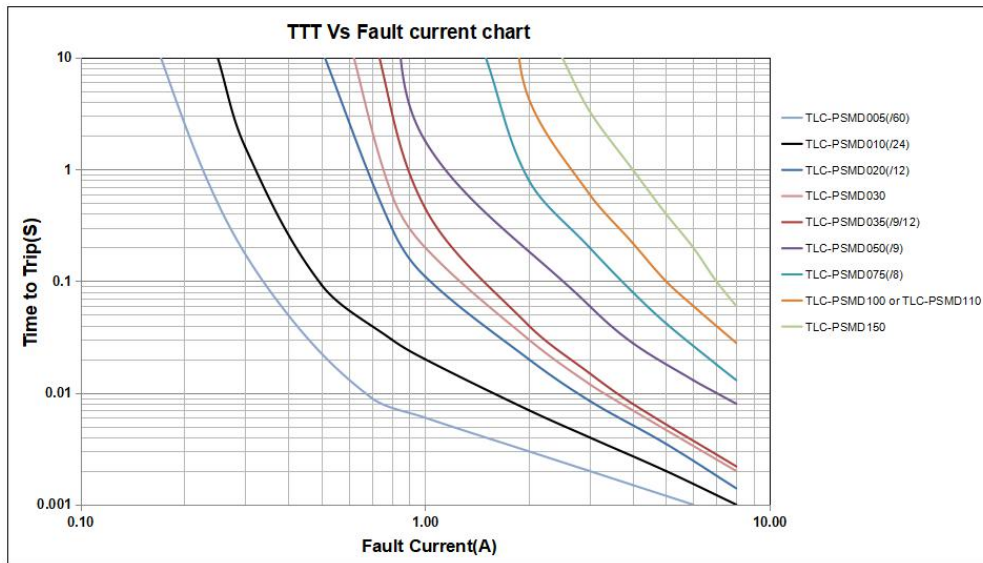

Note: TLC-PSMD005(/60) is represented for TLC-PSMD005 and TLC-PSMD005/60, and so on.

Reliability Requirement

Humidity Aging	+85°C, 85% R.H., 1000 hours ±5% Typical Resistance Change
Passive Aging	+85°C, 1000 hours ±5% Typical Resistance Change
Thermal Shock	30min@-40°C~30min@85°C, ,20cycles -33% Typical Resistance Change
Resistance to Solvents	MIL-STD-202, Method 215 Marking Still legible
Vibration	MIL-STD-833C, Method 2007.1, Condition A R min. < R i < R1max
Solderability	245°C±5°C, 5 Seconds >95% coverage

Environmental Characteristics

Operating/Storage Temperature -40 °C to +85 °C
 Maximum Device Surface Temperature in Tripped State 125 °C
 Storage Conditions +40 °C Max. 70% RH Max. Packed in original packaging.

Solder Reflow Conditions

Reflow Profile	Lead free
Heating rate from T _{smax} to T _p	Max.3°C/second
Pre-heat:	
T _{smin}	150°C
T _{smax}	200°C
T _{smin} to T _{smax}	60~180seconds
Soldering time:	>217°C
Temperature (T _L) Time (t _L)	60~150seconds
Peak temperature (T _p)	260°C
Time at Peak temperature ±5°C (t _p)	20~40seconds
Cooling rate	Max.6°C/second
Time from 25°C to Peak Temperature	8 minutes max

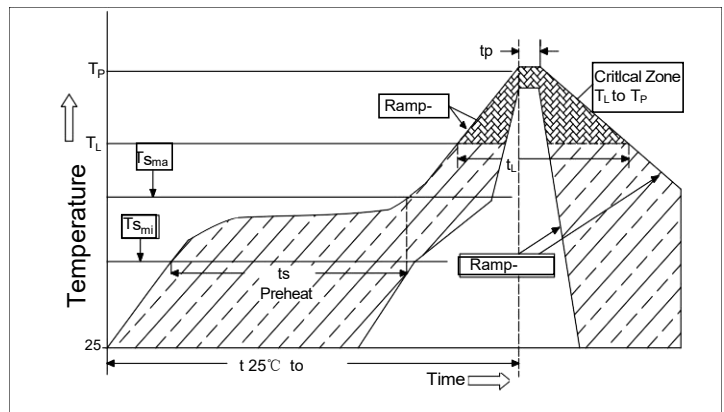

Warning for Reflow:

- 1、The printed solder thickness is not over 0.25mm, Excess solder may cause a short circuit, especially during hand soldering
- 2、If reflow temperatures exceed the recommended profile, devices may not meet the performance requirements
- 3、Device can't be wave soldered. Please contact TLC for hand soldering and dip soldering recommendations.
- 4、Device can't contact solvent

Note: All temperature in top chart is measured on the surface of devices

Product Dimensions & Marking (Unit: mm)

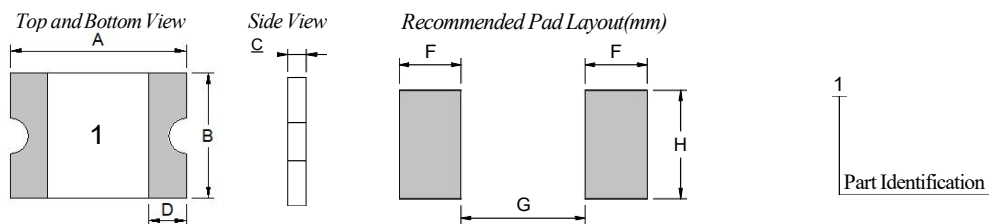

P/N	Marking	Device Dimension						Recommended Pad Layout(mm)			
		A		B		C		D	F	G	H
		Min.	Max.	Min.	Max.	Min.	Max.	Min.	Nor.	Nor.	Nor.
TLC-PSMD005		2.00	2.30	1.20	1.50	0.55	0.95	0.20	1.00	1.20	1.50
TLC-PSMD005/60		2.00	2.30	1.20	1.50	0.55	0.95	0.20	1.00	1.20	1.50
TLC-PSMD010	1	2.00	2.30	1.20	1.50	0.55	0.95	0.20	1.00	1.20	1.50
TLC-PSMD010/24	1	2.00	2.30	1.20	1.50	0.55	0.95	0.20	1.00	1.20	1.50
TLC-PSMD020	2	2.00	2.30	1.20	1.50	0.55	0.95	0.20	1.00	1.20	1.50
TLC-PSMD020/12	2	2.00	2.30	1.20	1.50	0.55	0.95	0.20	1.00	1.20	1.50
TLC-PSMD030	3	2.00	2.30	1.20	1.50	0.40	0.80	0.20	1.00	1.20	1.50
TLC-PSMD035	3	2.00	2.30	1.20	1.50	0.40	0.80	0.20	1.00	1.20	1.50
TLC-PSMD035/9	3	2.00	2.30	1.20	1.50	0.40	0.80	0.20	1.00	1.20	1.50
TLC-PSMD035/12	3	2.00	2.30	1.20	1.50	0.40	0.80	0.20	1.00	1.20	1.50

TLC-PSMD050	4	2.00	2.30	1.20	1.50	0.40	0.80	0.20	1.00	1.20	1.50
TLC-PSMD050/9	4	2.00	2.30	1.20	1.50	0.40	0.80	0.20	1.00	1.20	1.50
TLC-PSMD075	5	2.00	2.30	1.20	1.50	0.60	1.00	0.20	1.00	1.20	1.50
TLC-PSMD075/8	5	2.00	2.30	1.20	1.50	0.60	1.00	0.20	1.00	1.20	1.50
TLC-PSMD100	6	2.00	2.30	1.20	1.50	0.60	1.00	0.20	1.00	1.20	1.50
TLC-PSMD100/13.2	6	2.00	2.30	1.20	1.50	0.60	1.00	0.20	1.00	1.20	1.50
TLC-PSMD110	6	2.00	2.30	1.20	1.50	0.60	1.00	0.20	1.00	1.20	1.50
TLC-PSMD110/13.2	6	2.00	2.30	1.20	1.50	0.60	1.00	0.20	1.00	1.20	1.50
TLC-PSMD150	6	2.00	2.30	1.20	1.50	0.75	1.25	0.20	1.00	1.20	1.50

Packaging

P/N	Product size	Packaging Option	Quantity
TLC-PSMD005	0805	Tape&Reel	3500
TLC-PSMD005/60	0805	Tape&Reel	3500
TLC-PSMD010	0805	Tape&Reel	3500
TLC-PSMD010/24	0805	Tape&Reel	3500
TLC-PSMD020	0805	Tape&Reel	3500
TLC-PSMD020/12	0805	Tape&Reel	3500
TLC-PSMD030	0805	Tape&Reel	4500
TLC-PSMD035	0805	Tape&Reel	4500
TLC-PSMD035/9	0805	Tape&Reel	4500
TLC-PSMD035/12	0805	Tape&Reel	4500
TLC-PSMD050	0805	Tape&Reel	4500
TLC-PSMD050/9	0805	Tape&Reel	4500
TLC-PSMD075	0805	Tape&Reel	3500
TLC-PSMD075/8	0805	Tape&Reel	3500
TLC-PSMD100	0805	Tape&Reel	3500
TLC-PSMD100/13.2	0805	Tape&Reel	3500
TLC-PSMD110	0805	Tape&Reel	3500
TLC-PSMD110/13.2	0805	Tape&Reel	3500
TLC-PSMD150	0805	Tape&Reel	3500

Product Ordering Number System

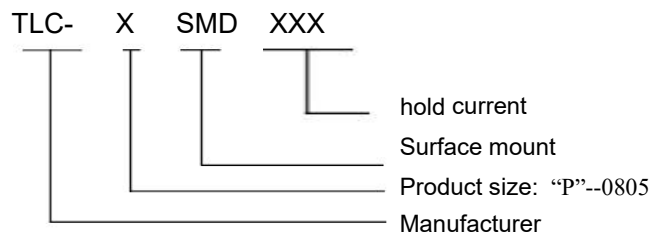

Tape and Reel Specifications

Dimensions for 0805 size product (see table below)

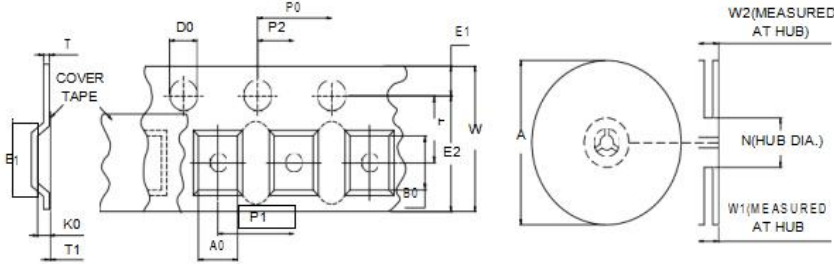

	TLC-PSMD030	TLC-PSM005/60	TLC-PSMD100
	TLC-PSMD035	TLC-PSMD010	TLC-PSMD100/13.2
	TLC-PSMD035/9	TLC-PSMD010/24	TLC-PSMD110
	TLC-PSMD035/12	TLC-PSMD020	TLC-PSMD110/13.2
	TLC-PSMD050	TLC-PSMD020/12	TLC-PSMD150
	TLC-PSMD050/9	TLC-PSMD075	
	TLC-PSMD005	TLC-PSMD075/8	
TAPE DIMENSIONS: EIA-481-1(mm)			
W	8.00±0.30	8.00±0.30	8.00±0.30
P0	4.00±0.10	4.00±0.10	4.00±0.10
P1	4.00±0.10	4.00±0.10	4.00±0.10
P2	2.00±0.05	2.00±0.05	2.00±0.05
A0	1.70±0.10	1.70±0.10	1.70±0.10
B0	2.45±0.10	2.45±0.10	2.45±0.10
B1max	4.35	4.35	4.35
D0	1.50+0.10/-0.00	1.50+0.10/-0.00	1.50+0.10/-0.00
F	3.50±0.05	3.50±0.05	3.50±0.05
E1	1.75±0.10	1.75±0.10	1.75±0.10
E2min	6.25	6.25	6.25
T max	0.60	0.60	0.60
T1min	0.10	0.10	0.10
K0	0.85±0.10	1.05±0.10	1.25±0.10
Leader min	390		
Trailer min	160		
Reel Dimensions: EIA-481-1(mm)			
A max	185		
N min	50		
W1	8.4+1.5/-0		
W2 max	14.4		

Cautions for SMD PPTC Use

1. Operation beyond the rated maximum voltage or current may result in device damage and possible electrical arcing or flame.
2. Hold current at all temperatures specified in the SPEC is the conventional performance of PTC obtained by one time reflow welding. PTC can hold 1 hour under current conditions at a given temperature. This current is not the condition of long-term charging or discharging current for this type of PTC.
3. The above parameters are concluded from one time of reflow soldering processing the PTC. If there is any further heat generated process like injection or dispensing at the customer's premise, the aforementioned parameters will decrease at certain degree. Therefore the verification test to be conducted is necessary.
4. The PTC is thermal sensitive device. It is recommended not to design any heat source devices around it to reduce the outside heat source impact.
5. SMD PTC is designed for SMT processing which applies reflow soldering. Please refer to the recommended solder reflow curve. If the reflow soldering temperature exceeds the recommended value, the PTC might be damaged. Hand welding PTC is prohibited. Heat gun is not allowed to use during the circuit board components or terminals rework .
6. Please do not smash, clamp, pull, dent or twist by tool during assembling process otherwise it might be a cause of the performance degradation.
7. PTC is resettable protection device which shall not be taken for use as switch. Multiple times tripping shall lower the PTC hold current.
8. In the process of PTC processing, if there is soldering iron welding process, it is suggested that the welding position should be more than 1.5mm away from PTC, the welding tool temperature should be lower than 350 °C, and the contact time between soldering iron and solder joint should not exceed 3sec.